

08/2014

Mod: E22/BM8T-N

Production code: 393125



Diamond
catering equipment

CONTENTS

I. JOINING APPLIANCES / TABLES	2
II. DATAPLATE and TECHNICAL DATA	15
III. GENERAL INSTRUCTIONS	16
IV. THE ENVIRONMENT	17
1. PACKING	17
2. USE	17
3. CLEANING	17
4. DISPOSAL	17
V. INSTALLATION	17
1. REFERENCE STANDARDS	17
2. UNPACKING	17
3. POSITIONING	17
4. FUME EXHAUST	18
5. CONNECTIONS	18
6. SAFETY THERMOSTAT	20
7. BEFORE COMPLETING INSTALLATION OPERATIONS	20
VI. INSTRUCTIONS FOR THE USER	20
1. BAINE MARIE USE	20
2. CHIP SCUTTLE USE	21
VII. CLEANING	22
1. EXTERNAL PARTS	22
2. OTHER SURFACES	22
3. SCALE	22
4. IDLE PERIODS	22
5. INTERNAL PARTS	22
VIII. MAINTENANCE	23
1. MAINTENANCE	23

II. DATAPLATE and TECHNICAL DATA

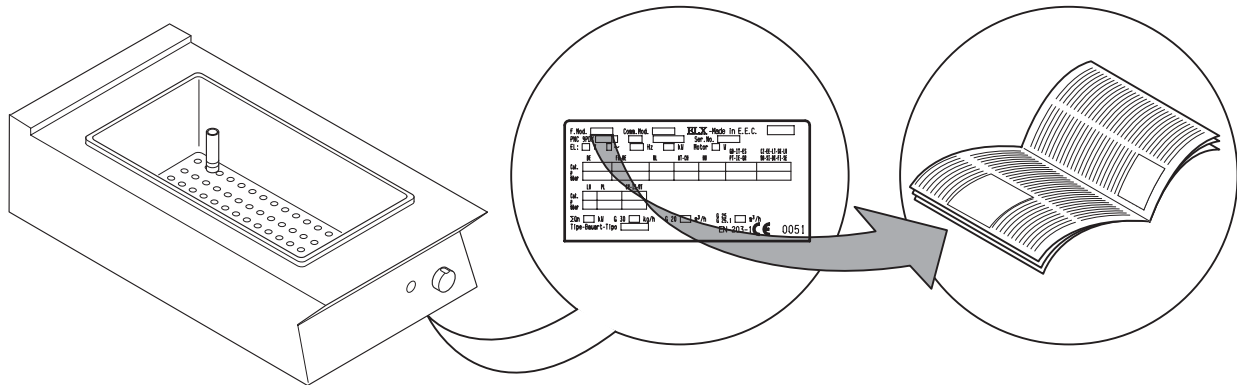

ATTENTION

This manual contains instructions relevant to various appliances. See the dataplate located under the control panel to identify the appliance (see fig. above).

TABLE A - Gas appliance technical data			
MODELS		+9BMGDB000 400mm	+9BMGHB000 800mm
TECHNICAL DATA			
Tank capacity	Max L	26	52
Connection ISO 7/1	Ø	1/2"	1/2"
Nominal heat output	kW	3	6.2
Type of construction		A1	A1

TABLE C - Electrical appliance technical data				
MODELS		BAINE MARIE		CHIP SCUTTLE
		+9BMEDB000 400mm	+9BMEHB000 800mm	+9CSEDC000 400mm
TECHNICAL DATA				
Power supply voltage	V	230	400	230
Phases	No.	1+N	3+N	1+N
Frequency	Hz	50/60	50/60	50/60
Nominal max. power	kW	2.2	6.6	1
Power cable section	mm ²	1.5	1.5	1.5

III. GENERAL INSTRUCTIONS



- Read the instruction manual carefully before using the appliance.

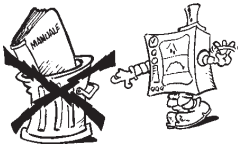

- Keep the instruction manual for future reference.



- **RISK OF FIRE** - Keep the area around the appliance free and clear of combustibles. Do not keep flammable materials in the vicinity of this appliance.



- Install the appliance in a well-ventilated place to avoid the creation of dangerous mixtures of unburnt gases in the same room.

- Air recirculation must take into account the air necessary for combustion $2 \text{ m}^3/\text{h/kW}$ of gas power, as well as the well-being of persons working in the kitchen.
- Inadequate ventilation causes asphyxia. Do not obstruct the ventilation system in the place where this appliance is installed. Do not obstruct the vents or ducts of this or other appliances.



- Place emergency telephone numbers in a visible position.

- Installation, maintenance and conversion to another type of gas must only be carried out by qualified personnel authorised by the manufacturer. For assistance, contact an authorised service centre. Demand original replacement parts.
- This appliance is designed for cooking food. It is intended for industrial use. Any use different from that indicated is **improper**.
- This appliance is not intended for use by people (including children) with limited physical, sensory or mental abilities or without experience and knowledge of it, unless they are supervised or instructed in its use by a person responsible for their safety.

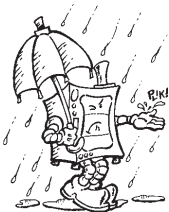

- Personnel using the appliance must be **trained**. Do not leave the appliance unattended when in use.
- Turn the appliance off in case of a fault or poor operation.
- Do not use products (even if diluted) containing chlorine (sodium hypochlorite, hydrochloric or muriatic acid, etc.) to clean the appliance or the floor under it. Do not use metal implements to clean steel parts (wire brushes or Scotch Brite type scouring pads).

- Do not allow oil or grease to come into contact with plastic parts.
- Do not allow dirt, fat, food or other residuals to form deposits on the appliance.
- Do not clean the appliance with direct jets of water.
- The symbol  given on the product indicates that it should **not** be considered domestic waste, but must be correctly disposed of in order to prevent any negative consequences for the environment and the health of people. For further information regarding the recycling of this product, contact the product agent or local dealer, the after-sales service or the local body responsible for waste disposal.

Failure to observe the above can compromise the safety of the appliance. Failure to observe the above invalidates the warranty.

IV. THE ENVIRONMENT

1. PACKING



The packing materials are environmentally friendly and can be stored without risk or burned in an appropriate waste incineration plant.

Recyclable plastic components are marked with:



Polyethylene: outer wrapping, instruction booklet, gas nozzle bag.



Polypropylene: roof packing panels, straps.



Polystyrene foam: corner protectors.

2. USE

Our appliances offer high performance and efficiency. To reduce electricity, water or gas consumption, do not use the appliance empty or in conditions that compromise optimum efficiency (e.g. with doors or lids open, etc.); the appliance must be used in a well-ventilated place, to avoid the creation of dangerous mixtures of unburnt gases in the room.

When possible, preheat only before use.

3. CLEANING

In order to reduce the emission of pollutants into the environment, clean the appliance (externally and when necessary internally) with products that are more than 90% biodegradable (for further information refer to section V "CLEANING").

4. DISPOSAL



Do not disperse in the environment. Our appliances are manufactured using more than 90% (in weight) recyclable metals (stainless steel, iron, aluminium, galvanised sheet, copper, etc.).

Make the appliance unusable by removing the power cable and any compartment or cavity closing devices (when present) in order to avoid the risk of someone becoming trapped inside.

V. INSTALLATION



• Carefully read the installation and maintenance procedures given in this instruction manual before installing the appliance.

- Installation, maintenance and conversion to another type of gas must only be carried out by qualified personnel authorised by the manufacturer.
- Failure to observe the correct installation, conversion and modification procedures can result in damage to the appliance, danger to people, and invalidates the Manufacturer's warranty.

1. REFERENCE STANDARDS

- Install the appliance in accordance with the safety regulations and local laws of the country where used.
- **ITALY:** install the appliance in compliance with UNI-CIG 8723 safety standards, Law No. 46 of 5 March 1990 and Min. Decree 12-4-96.

2. UNPACKING

ATTENTION!

Immediately check for any damage caused during transport.

- The forwarder is responsible for the safety of the goods during transport and delivery.
- Inspect the packs before and after unloading.
- Make a complaint to the forwarder in case of visible or hidden damage, reporting any damage or shortages on the dispatch note upon delivery.
- The driver must sign the dispatch note: the forwarder can reject the claim if the dispatch note is not signed (the forwarder can provide the necessary form).



• Unpack, taking care not to damage the appliance. Wear protective gloves.

- Carefully remove the protective film from metal surfaces and clean any traces of glue with a suitable solvent.
- For hidden damage or shortages becoming apparent only after unpacking, request the forwarder for inspection of the goods within and not later than 15 days of delivery.
- Keep all the documentation contained in the packing.

3. POSITIONING

- Handle the appliance with care in order to avoid damage or danger to people. Use a pallet for handling and positioning.
- The installation diagram provided in this instruction manual gives the appliance overall dimensions and the position of connections (gas, electricity, water). Check that they are available and ready for making all the necessary connections.
- The appliance can be installed separately or combined with other appliances of the same range.
- The appliances are not suitable for recess-mounting. Leave at least 10 cm between the appliance and side or rear walls.
- Suitably insulate surfaces that are at distances less than that indicated.
- Maintain an adequate distance between the appliance and any combustible walls. Do not store or use flammable materials and liquids near the appliance.
- Leave an adequate space between the appliance and any side walls in order to enable subsequent servicing or maintenance operations.
- Check and if necessary level the appliance after positioning. Incorrect levelling can cause appliance malfunctioning.

3.1. JOINING APPLIANCES

- (Fig.1A) Undo the 4 fixing screws and remove the control panels of the appliances.
- (Fig.1B) Remove the fixing screw nearest the control panel, from each side to be joined.
- (Fig.1D) Bring the appliances together and level them by turning the feet until the tops match.
- (Fig.1C) Turn one of the two plates inside the appliances 180°.
- (Fig.1E) From inside the control panel of the same appliance, join them at the front side, screwing one M5x40 Hex Head screw (supplied) on the opposite insert.

3.2 INSTALLATION ON BRIDGE, CANTILEVER FRAME OR CEMENT PLINTH

Carefully follow the instructions enclosed with the corresponding accessory. Follow the instructions enclosed with the optional product chosen.

3.3 SEALING GAPS BETWEEN APPLIANCES

Follow the instructions enclosed with the optional sealing paste pack.

4. FUME EXHAUST

4.1. TYPE "A1" APPLIANCES

Position type "A1" appliances under an extractor hood to ensure removal of fumes and steam produced by cooking.

4.2 TYPE "B" APPLIANCES

(in conformity with the definition given in the Installation Technical Regulations DIN-DVGW G634: 1998)

Whenever the appliance dataplate specifies only type Axx, such appliances are not designed for being directly connected to a flue or fume exhaust pipe run to the outside. However, the same appliance can be installed under an extractor hood or similar forced extraction system for fumes.

4.2.1. CONNECTION FLUE

- Remove the grille from the fume exhaust.
- Install the connection flue, following the instructions supplied with the accessory (optional).

4.2.2. INSTALLATION UNDER AN EXTRACTOR HOOD

- Place the appliance under the extractor hood (fig. opposite).
- Raise the fume exhaust pipe without altering the section.
- Do not install dampers.
- The correct height of the exhaust pipe and the distance from the extractor hood must comply with the current regulations.
- The end of the exhaust pipe must be at least 1.8 m from the support surface of the appliance.

Note! The system must ensure that: a) the fume exhaust is not obstructed; b) the length of the exhaust pipe does not exceed 3 m. Use the adapter for connecting fume ducts of different diameters.

5. CONNECTIONS



- Any installation work or maintenance to the supply system (gas, electricity, water) must only be carried out by the utility company or an authorised installation technician.
- Refer to the appliance dataplate for the product code.
- See the installation diagram for the type and position of appliance connections.

5.1. GAS APPLIANCES

IMPORTANT! This appliance is arranged and tested to operate with G20 gas 20mbar; to convert it to another type of gas, follow the instructions in par. 5.1.6. of this section.

5.1.1. BEFORE CONNECTING

- Make sure the appliance is arranged for the type of gas to be used. Otherwise, carefully follow the instructions given in the section: "Gas appliance conversion / adjustment".
- Fit a rapid gas shutoff cock/valve ahead of each appliance. Install the cock/valve in an easily accessed place.

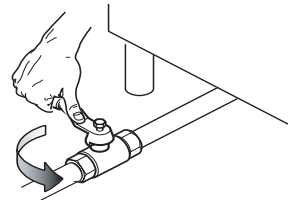

- Clean the pipes to remove any dust, dirt or foreign matter which could block the supply.
- The gas supply line must ensure the gas flow necessary for full operation of all the appliances connected to the system. A supply line with insufficient flow will affect correct operation of the appliances connected to it.
- **Attention!** Incorrect levelling of the appliance can affect combustion and cause malfunctioning.

5.1.2. CONNECTION

- Before connecting the appliance to the gas supply, remove the plastic protection cover from the gas connection on the appliance.
- The appliance is arranged for connection on the bottom right side; countertop models can be connected to the gas supply using the rear connection, after unscrewing the metal closing plug and screwing it tightly onto the front connection.
- After installation, use soapy water to check connections for leaks.

5.1.3. SUPPLY PRESSURE CHECK

Make sure the appliance is suitable for the type of gas available, according to that given on the dataplate (otherwise, follow the instructions given in the section "Conversion to another type of gas"). The supply pressure must be measured with the appliance operating, using a pressure gauge (min. 0.1 mbar).

- Remove the control panel.
- Remove retaining screw "N" from the pressure point and connect the pressure gauge "O" (fig. 2A and 2B).
- Compare the value read on the pressure gauge with that given in Table B (see handbook Appendix)
- If the pressure gauge gives a pressure outside the range of values in Table A, do not switch the appliance on. Consult the gas company.

5.1.4 GAS PRESSURE REGULATOR

- The section of the gas supply line must be sufficient to ensure the gas flow necessary for full operation of all the appliances connected to the system.

If the gas pressure is higher than that specified or is difficult to regulate (not stable), install a gas pressure regulator (accessory code 927225) in an easily accessed position ahead of the appliance.

The pressure regulator should preferably be fitted horizontally, to ensure the right outlet pressure:

- “1” connection side gas from mains.
- “2” pressure regulator;
- “3” connection side gas towards the appliance;

The arrow on the regulator () indicates the gas flow direction.

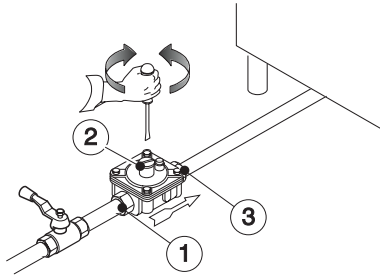

NOTE! These models are designed and certified for use with natural or propane gas. For natural gas, the pressure regulator on the header is set to 8" w.c. (20mbar).

5.1.5. PRIMARY AIR CHECK

The primary air is correctly adjusted when the flame does not “float” with the burner cold and there is no flareback with the burner hot.

- Undo screw “A” and position aerator “E” at distance “H” given in Table A; retighten screw “A” and seal with paint (fig. 3A).

5.1.6. CONVERSION TO ANOTHER TYPE OF GAS

Table B “technical data/gas nozzles” gives the type of nozzles to be used when replacing those fitted by the manufacturer (the number is stamped on the nozzle body). At the end of the procedure, carry out the following check-list:

Check	Ok
• burner nozzle/s replacement	
• correct adjustment of primary air supply to burner/s	
• pilot nozzle/s replacement	
• minimum flame screw/s replacement	
• correct adjustment of pilot/s if necessary	
• correct adjustment of supply pressure (see technical data/gas nozzles table)	
• apply sticker (supplied) with data of new gas type used	

5.1.6.1 MAIN BURNER NOZZLE REPLACEMENT

- Unscrew nozzle “C” and replace it with one suitable for the type of gas (Table B, fig.3A) according to that given in the following table.
- The nozzle diameter is given in hundredths of mm on the nozzle body.
- Retighten nozzle “C”.

5.1.6.2 PILOT BURNER NOZZLE REPLACEMENT

- Undo screw coupling “H” and replace nozzle “G” with one suitable for the type of gas (Table B, fig.3B).
- The nozzle identification number is given on nozzle body.
- Retighten screw coupling “H”.

5.2. ELECTRIC APPLIANCES

5.2.1. ELECTRICAL CONNECTION (Fig. 4A-Table C).

IMPORTANT! Before connecting, make sure the mains voltage and frequency match that given on the dataplate.

- To access the terminal board, remove the control panel of the appliance by removing the fixing screws (fig. 4A 1-2).
- Connect the power cable to the terminal block as shown in the wiring diagram attached to the appliance.
- Secure the power cable with the cable gland.

IMPORTANT! The manufacturer declines any liability if the safety regulations are not respected.

5.2.2. POWER CABLE

Unless otherwise specified, our appliances are not equipped with a power cable. The installer must use a flexible cable having characteristics at least equivalent to H05RN-F rubber-insulated type. Protect the cable section outside the appliance with a metal or rigid plastic pipe.

5.2.3. CIRCUIT BREAKER

Install a circuit breaker ahead of the appliance. The contact opening distance and maximum leakage current must comply with the current regulations.

5.3. EQUIPOTENTIAL NODE AND EARTH CONNECTION

Connect the appliance to an earth; it must be included in an equipotential node by means of the screw located at the front right under the frame. The screw is marked with the symbol .

6. SAFETY THERMOSTAT

Some of our appliance models use a safety thermostat that cuts in automatically when temperatures exceed a set value, shutting off the gas supply (gas appliances) or the electricity (electric appliances).

6.1. RESET

- Wait until the appliance has sufficiently cooled down.
- Press the red button on the safety thermostat body.

IMPORTANT! If resetting requires the removal of a protection part (e.g. control panel) this must be done by a specialised technician. Tampering with the safety thermostat invalidates the warranty.

7. BEFORE COMPLETING INSTALLATION OPERATIONS

Use soapy water to check all gas connections for leaks. DO NOT use a naked flame to check for gas leaks. Light all the burners separately and also together, to check correct operation of the gas valves, rings and lighting. For each burner, adjust the flame regulator to the lowest setting, individually and together; after completing the operations, the installer must instruct the user on the correct method of use. If the appliance does not work properly after carrying out all the checks, contact the local after-sales service centre.

VI. INSTRUCTIONS FOR THE USER

1. BAIN MARIE USE

General precautions

- The appliance is intended for industrial use by trained personnel.
- This appliance must only be used for its expressly designed purpose; i.e. for indirect cooking in containers and for keeping food hot in bain-marie. Any other use is deemed improper.
- Do not use the appliance empty or in conditions that compromise its optimum efficiency. Also, if possible, preheat the appliance immediately before use.

1.1. WATER FILLING

Fill the tank with water up to the level indicated by the reference notch on the rear wall. Overflow pipe "F" guarantees the removal of excess water.

Attention!

Never us the bain-marie without water in the tank (dry).

1.2. GAS MODELS

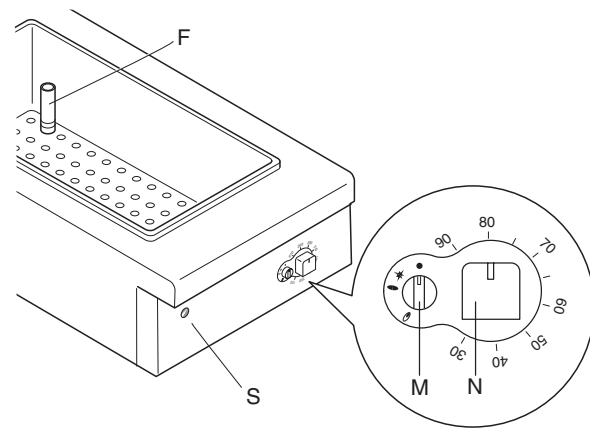

Switching on

The thermostatic valve control knobs have the following positions:

Knob M:

- "Off"
- ★ "Pilot ignition"
- 🔥 "Pilot on"
- "On"

- Turn knob "M" anticlockwise from position ● to position ★.
- Press down knob "M" and turn it to position 🔥 to light the pilot. If the pilot does not light, repeat the operation until it does.

Then, hold knob "M" down for about 20 seconds, release it and check that the pilot flame remains lit; otherwise, repeat the entire operation.

Attention! Whenever turning the knob to "Off", switching off the pilot burner, wait 60 seconds (knob release) before relighting it.

- To light the main burner, turn knob “M” anticlockwise from position 0 to position 0.
 - To adjust the temperature turn knob “N” to the required value.
- NOTE!** In case of emergency, the pilot burner can be lit manually by bringing a flame to it through hole “S” and keeping knob “M” pressed in the “Pilot ignition” position.

Switching off

- Turn knob “M” clockwise from position 0 to position *.
- Press the knob down and turn it to position *; release and turn it to position •.

1.3. ELECTRIC MODELS

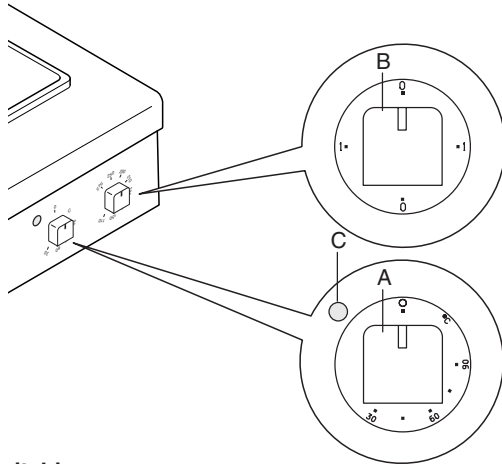

Switching on

- Turn on the main switch located ahead of the appliance.
- For 800mm models: turn the knob of switch “B” to position “1”
- Turn thermostat knob “A” to the required temperature.
- Lighting up of green indicator “C” indicates that the machine is on.

Switching off

Turn the control knobs to “0”.

1.4. WATER DISCHARGE

After cooking, empty the water tank, removing the overflow pipe “F” to prevent corrosive deposits inside the tank.

2. CHIP SCUTTLE USE

General precautions

- The appliance is intended for industrial use by trained personnel.
- This appliance must only be used for its expressly designed purpose; i.e. for keeping fried food hot. Any other use is deemed improper.

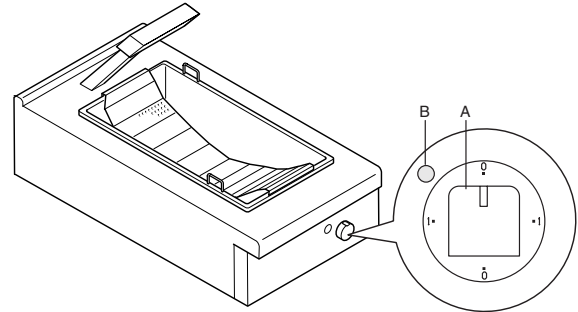

Switching on

- Turn on the main switch located ahead of the appliance.
- Turn the knob of switch “A” to position “1”. Lighting up of indicator “B” signals that the appliance is on and heating is by an infrared lamp (heating element).

Switching off

- Turn control knob “A” to the off position “0”.
- Turn off the electrical switch installed ahead of the appliance.

VII. CLEANING

IMPORTANT!

Disconnect the appliance from the power supply before carrying out any cleaning.

1. EXTERNAL PARTS

SATIN-FINISH STEEL SURFACES (daily)

- Clean all steel surfaces: dirt is easily removed when it has just formed.
- Remove grime, fat and other cooking residuals from steel surfaces when cool using soapy water, with or without detergent, and a cloth or sponge. Dry the surfaces thoroughly after cleaning.
- In case of encrusted grime, fat or food residuals, go over with a cloth or sponge, wiping in the direction of the satin finish and rinsing often: rubbing in a circular motion combined with the particles of dirt on the cloth/sponge could spoil the steel's satin finish.
- Metal objects can spoil or damage the steel: damaged surfaces become dirty more easily and are more subject to corrosion.
- Restore the satin finish if necessary.

SURFACES BLACKENED BY HEAT (when necessary)

Exposure to high temperatures can cause the formation of dark marks. These do not constitute damage and can be removed by following the instructions given in the previous section.

2. OTHER SURFACES

HEATED TANKS/CONTAINERS (daily)

Clean the appliance tanks or containers using boiled water, adding soda (degreasing) if necessary. Use the accessories (optional or supplied) specified in the list to eliminate encrustations or food deposits.

3. SCALE

STEEL SURFACES (when necessary)

Remove any scale (stains or marks) left by water on steel surfaces using suitable natural detergents (e.g. vinegar) or chemical (e.g. "STRIPAWAY" produced by ECOLAB).

BOILERS OR CAVITIES (at least monthly)

- Descale the devices used for holding and heating of water (e.g. cavities of indirect pots) by filling them with pure vinegar or a solution of chemical detergent (1/3) and water (2/3).

VINEGAR

- Heat for about 5 minutes
- Allow the vinegar to work for at least 20 minutes.
- Rinse with plenty of water.

CHEMICAL DETERGENT

- Heat for about 3 minutes
- Allow the solution to work for at least 10 minutes.
- Rinse with plenty of water.

4. IDLE PERIODS

If the appliance is not going to be used for some time, take the following precautions:

- Close the cocks or main switches ahead of the appliances.
- Go over all the stainless steel surfaces vigorously with a rag moistened with paraffin oil in order to create a protective film.
- Periodically air the premises.
- Have the appliance checked before using it again.
- To prevent too rapid evaporation of accumulated moisture with consequent breakage of elements, switch electric appliances on at minimum heat for at least 45 minutes before reuse.

5. INTERNAL PARTS (every 6 months)

IMPORTANT! Operations to be carried out only by specialised technicians.

- Check the internal parts.
- Remove any deposits of dirt inside the appliance.
- Check and clean the discharge system.

NOTE ! In particular ambient conditions (e.g. **intensive** use of the appliance, salty environment, etc.) the above-mentioned cleaning should be more frequent.

VIII. MAINTENANCE

1. MAINTENANCE

All components requiring maintenance are accessible from the front of the appliance, after removing the control panel and front panel. Disconnect the power supply before opening the appliance

1.1 BRIEF TROUBLESHOOTING GUIDE (bain-marie)

Even with normal use, malfunctions can occur.

- *the pilot burner does not light.*

Possible causes:

- The igniter is not properly fixed or connected.
- The ignition or the igniter cable are damaged.
- Insufficient pressure in gas pipes.
- Blocked nozzle.
- Faulty gas valve.

- *The pilot burner goes out when the igniter knob is released.*

Possible causes:

- The pilot burner is not heating the thermocouple sufficiently.
- Faulty thermocouple.
- The gas valve knob is not being pressed enough.
- Lack of gas pressure at the valve.
- Faulty valve.

- *The pilot burner is still lit but the main burner does not light.*

Possible causes:

- Loss of pressure in gas pipe.
- Blocked nozzle or faulty gas valve.
- Burner with gas outlet holes clogged.

INSTRUCTIONS FOR REPLACING COMPONENTS (to be carried out only by a specialised installer)

- *GAS VALVE*

- Remove the control panel, undoing the fixing screws.
- Unscrew the pilot burner pipe and thermocouple.
- Unscrew the valve gas inlet pipe.
- Replace the components, proceeding in reverse order to refit the parts.

- *PILOT BURNER, THERMOCOUPLE, IGNITER ASSEMBLY*

- To replace the igniter and thermocouple loosen the fixing screws and remove the components.
- To replace the pilot burner undo the gas pipe and the two fixing screws.
- Replace the components, proceeding in reverse order to refit the parts.

- *MAIN BURNER*

- Unscrew the gas connection from the nozzle holder.
- Remove the pilot burner, undoing the fixing screws.
- Remove the burner front panel fixed with screws.
- Undo the burner fixing screws.
- Replace the components, proceeding in reverse order to refit the parts.

1.2 MAINTENANCE SCHEDULE

- It is advisable to have the appliance inspected by an authorised person at least every 12 months. For this purpose, it is advisable to stipulate a servicing contract.